

**LOS RIOS COMMUNITY COLLEGE DISTRICT PURCHASE ORDER NO 0001103309  
CHANGE ORDER**

PURCHASING: (916) 568-3071 • FAX: (916) 568-3145  
ACCOUNTING OPS: (916) 568-3065 • FAX: (916) 286-3636

Date	Revision	Page
01/11/2019	1 - 04/03/2019	1
Payment Terms	Freight Terms	Ship Via
NET 30	Shipping Point	Best Metho
Reference:	Location / Dept	
1016514 ZWERENZK HANEYB	04EDCA103 EDC	

PLEASE SEE REVERSE SIDE FOR TERMS AND CONDITIONS.

Supplier: 0000006424  
AMAZON.COM  
BILLING DEPARTMENT  
P O BOX 80463  
SEATTLE WA 98108

Ship To: EL DORADO CENTER  
RECEIVING  
6699 CAMPUS DR  
PLACERVILLE CA 95667  
United States

email:

Bill To: 1919 Spanos Court  
Sacramento CA 95825-3981  
United States

Tax Exempt? N

Line-Sch	Item/Description	Quantity UOM	PO Price	Extended Amt	Due Date
1- 1	SHRINK MACHINE BENCH TOP BY FERRARI	2.00 EA	160.00	320.00	01/10/2019
2- 1	FRUIT PRESS 36 LITER MAXIMIZER WITHOUT GSAM	1.00 EA	439.95	439.95	01/10/2019

PO# 0001103309

LINE# 1 Order Number: 113-8919462-2774655  
Bench Top PVC Shrink Machine will be shipped to El Dorado Center - Receiving by Winemakers Depot.  
Estimated delivery: Jan. 16, 2019 - Jan. 22, 2019

LINE# 2 Order Number: 113-0138741-6797046  
Maximizer Fruit Press 36 Liter will be shipped to El Dorado Center - Receiving by Pleasant Hill  
Grain.  
Estimated delivery: Jan. 16, 2019 - Jan. 18, 2019

ORDER CORRECTION FOR LINE# 1: PO QTY 2 - BH

Order Number 113-8919462-2774655 - PLACED 01/10/19, FOR QTY 1 ONLY / RCVD 01/16/19.

Order Number: 113-3202816-6639454 - PLACED 04-03-19, FOR QTY 1  
Bench Top PVC Shrink Machine will be shipped to El Dorado Center - Receiving by Winemakers Depot.  
Estimated delivery: April 9, 2019 - April 12, 2019

Sub Total Amount	759.95
Sales Tax Amount	55.10
Total PO Amount	815.05

<u>BU</u>	<u>Acct</u>	<u>Fd</u>	<u>Org</u>	<u>Prog</u>	<u>Sub</u>	<u>Proj</u>	<u>Amount</u>	<u>BYear</u>
GENFD	6490	12	FL.VI.SWPA	01040	00000	482Y	815.05	2019

All shipments, invoices, and correspondence must be identified with our Purchase Order Number. Overshipments will not be accepted unless authorized by Buyer prior to shipment.

Authorized Signature

Notice to vendor: You are responsible for delivering goods and delivery documents to the Receiving Department at the site. Failure to do so will delay payment processing. Vendor is responsible for obtaining verification of delivery by authorized Receiving Room personnel. Receipt of goods by other parties and failure to obtain authorized signatures may also delay payment. NOTE: PAYMENT TERMS NET 30  
MATERIAL SAFETY DATA SHEETS (MSDS) must be provided with the delivery of product as required by law.

# LOS RIOS COMMUNITY COLLEGE DISTRICT

PURCHASE ORDER NO 0001103309

PP

PURCHASING: (916) 568-3071 • FAX: (916) 568-3145  
 ACCOUNTING OPS: (916) 568-3065 • FAX: (916) 286-3636

Date	Revision	Page
01/11/2019		1
Payment Terms	Freight Terms	Ship Via
NET 30	Shipping Point	Best Metho
Reference:	Location / Dept	
1016514 ZWERENZK HANEYB	04EDCA103 EDC	

PLEASE SEE REVERSE SIDE FOR TERMS AND CONDITIONS.

Supplier: 0000006424  
 AMAZON.COM  
 BILLING DEPARTMENT  
 P O BOX 80463  
 SEATTLE WA 98108

Ship To: EL DORADO CENTER  
 RECEIVING  
 6699 CAMPUS DR  
 PLACERVILLE CA 95667  
 United States

email:

Bill To: 1919 Spanos Court  
 Sacramento CA 95825-3981  
 United States

Rcvr # 0001087186 1/16/19 \$241

Tax Exempt? N

Line-Sch	Item/Description	Quantity UOM	PO Price	Extended Amt	Due Date
1- 1	SHRINK MACHINE BENCH TOP BY FERRARI	2.00 EA	160.00	320.00	01/10/2019
2- 1	FRUIT PRESS 36 LITER MAXIMIZER WITHOUT GSAM	1.00 EA	439.95	439.95	01/10/2019

Partially 1/2

PO# 0001103309

Order Number: 113-8919462-2774655  
 Bench Top PVC Shrink Machine will be shipped to El Dorado Center - Receiving by Winemakers Depot.  
 Estimated delivery: Jan. 16, 2019 - Jan. 22, 2019

Order Number: 113-0138741-6797046  
 Maximizer Fruit Press 36 Liter will be shipped to El Dorado Center - Receiving by Pleasant Hill Grain.  
 Estimated delivery: Jan. 16, 2019 - Jan. 18, 2019

PAID  
 \$643.95

chk # 94-774909 2/13/19

line # 1 was partially paid.

Sub Total Amount	759.95
Sales Tax Amount	55.10
Total PO Amount	815.05

BU	Acct	Fd	Org	Prog	Sub	Proj	Amount	BYear
GENFD	6490	12	FL.VI.SWPA	01040	00000	482Y	815.05	2019

ENTERED  
 MS

0001016514CHAVEZA08--JAN-2019

Verification of this purchase order can be made using the Los Rios Community College District web site listed below. If you have any questions, please contact the Purchasing Office at (916)568-3071.

All shipments, invoices, and correspondence must be identified with our Purchase Order Number. Overshipments will not be accepted unless authorized by Buyer prior to shipment.

Authorized Signature

*A-JL*

1/22/19 Baba emailed & confirmed full delivery (see attachment)

2/5 will pay 2/14

Notice to vendor: You are responsible for delivering goods and delivery documents to the Receiving Department at the site. Failure to do so will delay payment processing. Vendor is responsible for obtaining verification of delivery by authorized Receiving Room personnel. Receipt of goods by other parties and failure to obtain authorized signatures may also delay payment. NOTE: PAYMENT TERMS NET 30  
 MATERIAL SAFETY DATA SHEETS (MSDS) must be provided with the delivery of product as required by law.

## LOS RIOS COMMUNITY COLLEGE DISTRICT

American River College • Cosumnes River College • Folsom Lake College • Sacramento City College

### PURCHASE ORDER TERMS AND CONDITIONS

1. **APPLICABLE LAW:** The contract resulting from this order shall be governed by the laws of the State of California
2. **COMPLETION OF ORDERS:** LRCCD reserves the right to withhold payment until order is completed.
3. **DISCOUNTS:** Please show cash payment discount offered on your invoice in connection with any discount offered, time will be computed from date of delivery of the supplies or equipment, or from date correct invoices are received in the office specified by LRCCD if the latter date is later than the date of delivery. Payment is deemed to be made for the purpose of earning discount, on the date payment is mailed or on behalf of LRCCD.
4. **INVOICES:** Invoices shall be prepared and submitted in duplicate unless otherwise specified. Invoices shall contain Purchase order number, date, description of items, sizes and quantities, unit prices, extended totals, place and date of delivery. Invoices or vouchers not on printed bill heads shall be signed by the CONTRACTOR or person furnishing the supplies or services. Every invoice shall be properly itemized. If LRCCD has not received billing for product or services within a one year period LRCCD will not be held responsible for satisfying the debt.
5. **CHANGES:** No change or modification in terms, quantities, or specifications may be made without express authorization in writing from the LRCCD Purchasing Office and signed by the parties hereto, and no oral understanding or agreement not incorporated herein shall be binding on any of the parties hereto. If unit cost of any item exceeds the amount shown by 10% or \$250.00 whichever is less do not ship. Contact LRCCD Purchasing at the phone number provided.
6. **BILL OF LADING:** If Bill of Lading is applicable to this order, send originals to "Ship to" address and duplicate Bill of Lading with invoices to "Bill to" address. All correspondence, invoices, bills of lading, shipping memos, packages, etc., must show purchase order number. If factory shipment, advise factory to comply.
7. **TRANSPORTATION CHARGES:** Invoices for prepaid transportation charges must be supported by original receipted expense bills.
8. **FOB POINT AND FREIGHT CHARGES:** Unless otherwise specified on this order, all items shall be delivered FOB Destination. No charge for delivery, drayage, express, parcel post, packing, cartage, insurance, license fees, permits, or for any other purpose will be paid by LRCCD unless expressly included and itemized in the order. Unless otherwise shown, on "FOB Shipping Point" transactions, CONTRACTOR shall arrange for lowest cost transportation, prepay and add freight to invoice and furnish supporting freight bills if the amount exceeds \$50.00. On "FOB Shipping Point" transactions, should any shipments under this purchase order be received by LRCCD in a damaged condition and any related freight loss and damage claims filed against the carrier or carriers be wholly or partially declined with the inference that damage was the result of the act of the shipper such as inadequate packaging or loading or some inherent defect in the equipment and/or material, CONTRACTOR on request of LRCCD shall at CONTRACTOR's own expense assist LRCCD in establishing carrier liability by supplying evidence that the equipment and/or materials was properly constructed, manufactured, packaged, and secured to withstand normal transportation conditions. Shipments that are California intrastate in nature and where freight is to be borne by LRCCD shall be tendered to carriers with written instructions that rate and charges may not exceed the lowest lawful rates on file with the California Public Utilities Commission.
9. **PATENT INDEMNITY:** The CONTRACTOR shall hold LRCCD, its officers, agents and employees harmless from alleged liability of any nature or kind, including costs and attorney fees and expenses, for infringement or use of any copyrighted or uncopyrighted composition, secret process, patented or unpatented invention, article or appliance furnished or used in connection with the contract or purchase order.
10. **TAXES:** Certain articles sold to LRCCD are exempt from certain Federal excise taxes. LRCCD will reimburse the CONTRACTOR for, or pay directly, all California State and local sales and use taxes applicable to this purchase.
11. **EQUAL OPPORTUNITY EMPLOYER:** The acceptance of this purchase order by a supplier of goods and services is a certification that such supplier complies with all provisions of executive order 11246 and is an equal opportunity employer.
12. **GENERAL SAFETY ORDERS:** All materials, supplies and services sold to LRCCD shall conform to the general safety orders of the State of California. All materials, except as otherwise specified, must be new and of the best quality of their respective kinds.
13. **INDEMNIFICATION:** CONTRACTOR shall indemnify, defend and hold harmless LRCCD, its trustees, officers, agents, employees and volunteers, from any and all claims, demands, suits, causes of action, damages, penalties, breaches of this agreement, infringement of patent rights, costs, expenses, violations of employee occupational health and safety laws, attorney fees, losses or liability, property damage, personal injuries to or death of persons, arising out of, alleged to have arisen out of, or relating in any way to CONTRACTOR's work to be performed under this agreement, except if caused solely by the negligence of LRCCD.
14. **TERMINATION:** LRCCD may terminate this agreement and be relieved of the payment of any consideration to CONTRACTOR should CONTRACTOR fail to perform the covenants herein contained at the time and in the manner herein provided. In the event of such termination LRCCD may proceed with the work in any manner deemed proper by LRCCD. The cost to LRCCD shall be deducted from any sum due the CONTRACTOR under this agreement and the balance if any, shall be paid the CONTRACTOR upon demand.
15. **ASSIGNMENT:** Without the written consent of LRCCD, this agreement is not assignable by CONTRACTOR either in whole or in part.
16. **PUBLIC WORKS PROJECTS:** CONTRACTOR must comply with Public Contract Code.
17. **CA LABOR CODE:** Pursuant to Section 1700, and following, the CONTRACTOR shall pay not less than the prevailing rate of per diem wages as determined by the Director of the California Department of Industrial Relations. Copies of such prevailing rate of per diem wages are on file at the Business Office of the Los Rios Community College District, 1919 Spanos Court, Sacramento, CA 95825. Those copies shall be made available to any interested party upon request. The CONTRACTOR shall forfeit, as penalty to the LRCCD, Fifty Dollars (\$50.00) for each calendar day or portion thereof, for each workman paid less than the stipulated prevailing rates for any work done under the contract by him/her or by any subcontractor under him, in violation of the provisions of such Labor Code.
18. **NOTICE:** Your employees may be exposed to hazardous substances during the course of their work while on LRCCD property. For additional information on the hazardous substances that your employees may be exposed to contact the LRCCD General Services Department at (916) 568-3048.
19. **INSURANCE:** CONTRACTOR shall, at all times, maintain in full force and effect the following insurance: Workers' Compensation, Commercial General Liability, Auto Liability, and Professional Liability if licensed professional. Policy limits for each shall be at least \$1,000,000 AND \$3,000,000 AGGREGATE for bodily injury, personal injury and property damage. Any combination of General Liability and Excess Coverage can be combined to meet the Aggregate. LRCCD shall be named as an additional insured on CONTRACTOR's policies. The CONTRACTOR shall provide a certificate of insurance and required endorsements to comply with this section at least 15 days prior to commencement of work under this contract. The certificate shall state that LRCCD will be given 30 days notice of any material change or cancellation in coverage.
20. **DISQUALIFIED EMPLOYEES:** CONTRACTOR shall ensure that persons who perform services on LRCCD property have not been convicted of any felony, or any controlled substance offense or any sex offense as those terms are defined by Education Code section 87008-87010. If LRCCD determines that any person employed by CONTRACTOR to work on LRCCD property is incompetent, unfaithful, intemperate, disorderly, abusive or is otherwise unsatisfactory, CONTRACTOR shall cause that employee to be removed from working on LRCCD property immediately, and that person shall not be employed again on LRCCD property.
21. **WORK AUTHORIZATION:** Prior to LRCCD's acceptance of this Agreement, CONTRACTORS who are not U.S. citizens must provide verification of (a) work authorization status from the appropriate U.S. Department of State; (b) a copy of their U.S. visa; (c) the number of days present in the U.S.; and (d) tax treaty status. LRCCD shall not make any payments to CONTRACTOR unless CONTRACTOR holds the appropriate U.S. visa. CONTRACTOR is responsible for ensuring they are in possession of the appropriate visa.
22. **WARRANTY:** CONTRACTOR expressly warrants that all materials, goods, equipment, services, and/or labor shall conform to the requirements set forth or incorporated into this order and any applicable industry standards or requirements, shall be merchantable and free from defects in workmanship, materials and/or design (including latent defects), and shall perform as specified. CONTRACTOR further warrants that all materials, goods, equipment, services, and/or labor will be fit and sufficient for the particular purposes intended by LRCCD. Unless agreed upon otherwise between LRCCD and CONTRACTOR, the warranty period shall be the longer of: (a) any express warranty included in this service agreement; (b) one year after the materials, goods, equipment, services, and/or labor are accepted by LRCCD; or (c) any warranty period provided under any applicable California law.

# Requisition

**Supplier:** AMAZON.COM  
 BILLING DEPARTMENT  
 P O BOX 80463  
 SEATTLE WA 98108  
 United States

FLC BUSINESS 0000006424E3

2009 JAN -8 P 12: 07

**email:**

**Ship To:** RECEIVING  
 6699 CAMPUS DR  
 PLACERVILLE CA 95667

<b>Business Unit:</b> GENFD OPEN	
Req ID: 0001016514	Date: 12/19/2018
Page: 1	
Requisition Name: AMAZON	
Requester: Kimberly Zwerenz	Bldg#: EDC
Requester Signature	
Buyer: Brenda Haney	
Approved:	
Entered By: ZWERENZK 19-DEC-2018	

Line-Schd	Description	Quantity	UOM	Price	Extended Amt	Due Date
1-1	SHRINK MACHINE BENCH TOP BY FERRARI	2	EA	169.99	339.98	12/31/2018
	ASSET DEPT: EDC LOCATION: 04EDCA103 CATEGORY: SUPP	2			PROFILE: EQP:OTHER	
2-1	CATCH STAND - PAINTED	1	EA	249.99	249.99	12/31/2018
	ASSET DEPT: EDC LOCATION: 04EDCA103 CATEGORY: SUPP	1			PROFILE: EQP:OTHER	
3-1	DESTEMMER MOTORIZED - STAINLESS STEEL HOPPER	1	EA	1,099.99	1,099.99	12/31/2018
	ASSET DEPT: EDC LOCATION: 04EDCA103 CATEGORY: SUPP	1			PROFILE: EQP:OTHER	
4-1	FRUIT PRESS 36 LITER MAXIMIZER WITHOUT GSAM	1	EA	493.95	493.95	12/31/2018
	ASSET DEPT: EDC LOCATION: 04EDCA103 CATEGORY: SUPP	1			PROFILE: EQP:OTHER	
5-1	SHIPPING FOR CRUSHER AND STAND	1	EA	384.49	384.49	12/31/2018
	ASSET DEPT: EDC LOCATION: 04EDCA103 CATEGORY: FEES	1			PROFILE: EQP:FEES	

2,568.40 Sub-total  
 158.33 Est. tax

Total Requisition Amount: 2,726.73

WEB PRICING

<u>BU</u> GENFD	<u>Acct</u> 6490	<u>Fd</u> 12	<u>Org</u> FL.VI.SWPA	<u>Prog</u> 01040	<u>Sub</u> 00000	<u>Proj</u> 482Y	<u>Amount</u> 2,568.40
--------------------	---------------------	-----------------	--------------------------	----------------------	---------------------	---------------------	---------------------------

Approval Signature 	Approval Signature 	Approval Signature
------------------------	------------------------	--------------------



Try Prime

All shrink machine bench top ferrari

Deliver to Sacramento 95825

Your Amazon.com Last-Minute Deals Gift Cards

EN Hello, Sign in Account & Lists Orders Try Prime 0 Cart

Industrial & Scientific Lab Test & Measurement Safety Janitorial & Facilities Food Service Education Material Handling Materials Metalworking Electrical



DIY RESOURCE CENTER How-to installation videos See more >

Industrial & Scientific > Packaging & Shipping Supplies > Industrial Shrink Wrap Supplies > Shrink Wrap Machines



by Ferrari

### Bench Top PVC Shrink Machine

15 customer reviews | 8 answered questions

Price: \$169.99 & FREE Shipping. Details

Expected to arrive after Christmas. Need a gift quickly? Send the gift of Prime or an Amazon Gift Card by email or text message.

New (3) from \$160.00 & FREE shipping.

\$169.99

& FREE Shipping. Details

Want it Thursday, Dec. 27?

Choose Two-Day Shipping at checkout. Details

In Stock.

Ships from and sold by Amazon.com. Gift-wrap available.

Qty: 1

Add to Cart

Turn on 1-Click ordering for this browser

Deliver to Sacramento 95825

Add to List

#### Other Sellers on Amazon

\$160.00

+ Free Shipping

Sold by: Winemakers Depot

Add to Cart

\$197.28

+ Free Shipping

Sold by: Home Brew Ohio

Add to Cart

New (3) from \$160.00 & FREE shipping.

Have one to sell?

Sell on Amazon

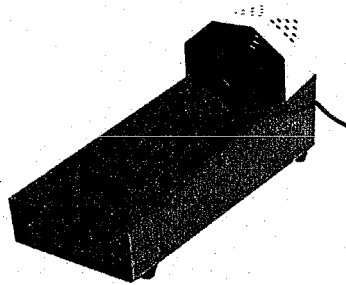

#### Specifications for this item

Part Number	6000	Height	1.0 inches
Number of Items	1	Included Components	PVC Shrink Machine
Lower Temperature Rating	1 degrees_fahrenh	Inside Diameter	1.0 inches
Measurement System	US	Material	Stainless Steel
UPC	742436736077	Model Number	6000
Brand Name	Ferrari	UNSPSC Code	40000000
Color	Silver	Width	1.0 inches
EAN	0742436736077		

Roll over image to zoom in

[See more product details](#)

#### Frequently bought together

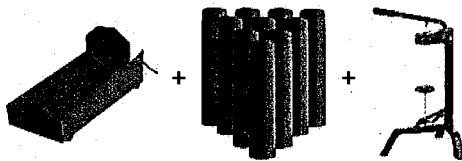

Total price: \$237.97

Add all three to Cart

Add all three to List

- ✓ **This item:** Bench Top PVC Shrink Machine \$169.99
- ✓ HomebrewSupply EL-5188-4KDR Shrink Capsules 100 Oriental Red Pvc Heat Shrink Caps For Wine Bottles... \$7.99 (\$0.08 / Shrink Cap)
- ✓ Home Brew Ohio Wine Bottle Floor Corer, Portuguese Red \$59.99

#### Customers who bought this item also bought



Try Prime

All catch stand painted

Deliver to Sacramento 95825

Your Amazon.com Last-Minute Deals Gift Cards

EN Hello. Sign in Account & Lists

Orders Try Prime

0 Cart

# Save up to 30% on Mattresses

Shop now >

Home & Kitchen > Kitchen & Dining > Home Brewing & Wine Making > Wine Making > Crushing, Pressing & Stemming

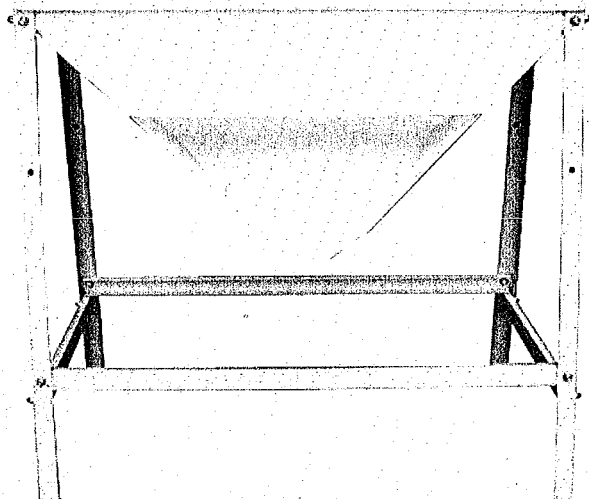

Click image to open expanded view

## Catch Stand- Painted

by Marchisio

1 customer review

Price: \$249.99 + \$56.49 shipping

Get \$50 off instantly. Pay \$199.99 upon approval for the Amazon Rewards Visa Card.

Expected to arrive after Christmas. Need a gift quickly? Send the gift of Prime or an Amazon Gift Card by email or text message.

- Painted steel body

New (1) from \$249.99 + \$56.49 shipping

prime student College student? Get FREE shipping and exclusive deals

\$249.99 + \$56.49 shipping

Get it as soon as Dec. 28 - Jan. 3 when you choose Expedited Shipping at checkout.

Only 1 left in stock - order soon.

Ships from and sold by The Grape and Granary, Inc.

\$249.99 + \$56.49 shipping

Add to Cart

Turn on 1-Click ordering for this browser

Deliver to Sacramento 95825

Add to List

Add to Wedding Registry

### Explore the Home Gift Guide



Instant Pots



Breville Appliances



Keurig Coffee Makers

Sell on Amazon

### Customers also shopped for

Page 1 of 3

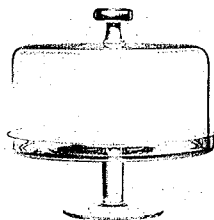

Barski Handmade Glass 2 pc Set, Footed Cake Plate with Dome, 12"H, 11"D (inside dome is 10.25"D),...

\$99.95



True Fabrications Used Wine Oak Barrel Lazy Susan and Serving Tray

\$166.49

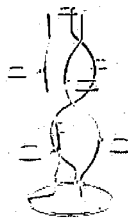

BestPysanky Silver Tone Metal 7 Eggs Holder Display Stand 7.25 Inches

\$21.74

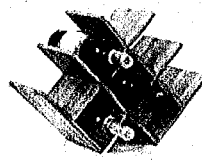

W Shape 8 Bottle Tabletop Wooden Wine Rack (Improved Oct. 2014)

\$35.00

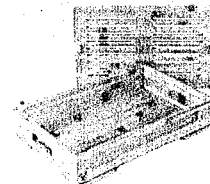

Elegant Bamboo Tea Tray

\$16.99

ATK Luxury Co Wood Brass Pc Coffee Dripper Wood Base - H Adjustable hei 1 offer from \$1

### Customers who viewed this item also viewed



Try Prime

All ▾ destemmer motorized stainless steel

Deliver to Sacramento 95825

Your Amazon.com Last-Minute Deals Gift Cards

EN Hello, Sign in Account & Lists

Orders Try Prime

0 Cart

# Cooks' Tools and More



Shop now

Home & Kitchen ▸ Kitchen & Dining ▸ Home Brewing & Wine Making ▸ Wine Making ▸ Crushing, Pressing & Stemming



## Destemmer Motorized- Stainless Steel Hopper

by Grape and Granary

Be the first to review this item

Deliver to Sacramento 95825

See All Buying Options

Available from these sellers.

- Painted hopper. Stems are discarded out the side.

Add to List

Add to Wedding Registry

New (1) from \$1,099.99 + \$328.00 shipping

Have one to sell?

Sell on Amazon

prime student College student? Get FREE shipping and exclusive deals

### Explore the Home Gift Guide



Instant Pots



Breville Appliances



Keurig Coffee Makers

Click image to open expanded view

### Customers also shopped for

Page 1 of 3

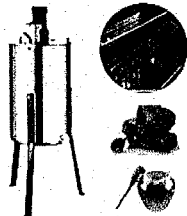

Happybuy LXXD Stainless Steel 2 Frame Electric Honey Extractor

9 \$229.96



Update International (JST-6) Stainless Steel Julep Strainer

94 \$3.96

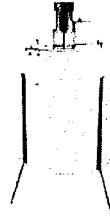

Happybuy 4XXD Stainless Steel 4 Frame Electric Honey Extractor

9 \$309.96

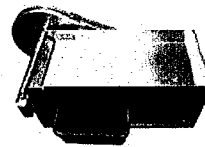

Taylor Little Sheller, the Pea and Bean Sheller

10 \$620.00

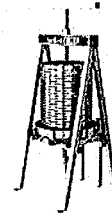

Harvest Fiesta Stainless Steel Fruit and Wine Press, 1S Liter

4 \$425.99



Stainless Steel USA Made Fruit Making Wine & Pressing Grapes

7 \$499.00

### Customers who viewed this item also viewed



All ▾ maximizer fruit press

**4 days left Prime FREE 2-Day Shipping**

Deliver to kimberly  
Placerville 95667

Buy Again    Browsing History ▾    Kim's Amazon.com

EN ▾    Hello, Kim    Account & Lists ▾    Orders    Prime ▾    0    Cart

Amazon Home    Shop by Room    Scout | Style Explorer    Shop by Style    Home Décor    Furniture    Kitchen & Dining    Bed & Bath    Garden & Outdoor    Home In

**Save up to 25% on Ashley Furniture**    Shop now ▾

◀ Back to search results for "maximizer fruit press"

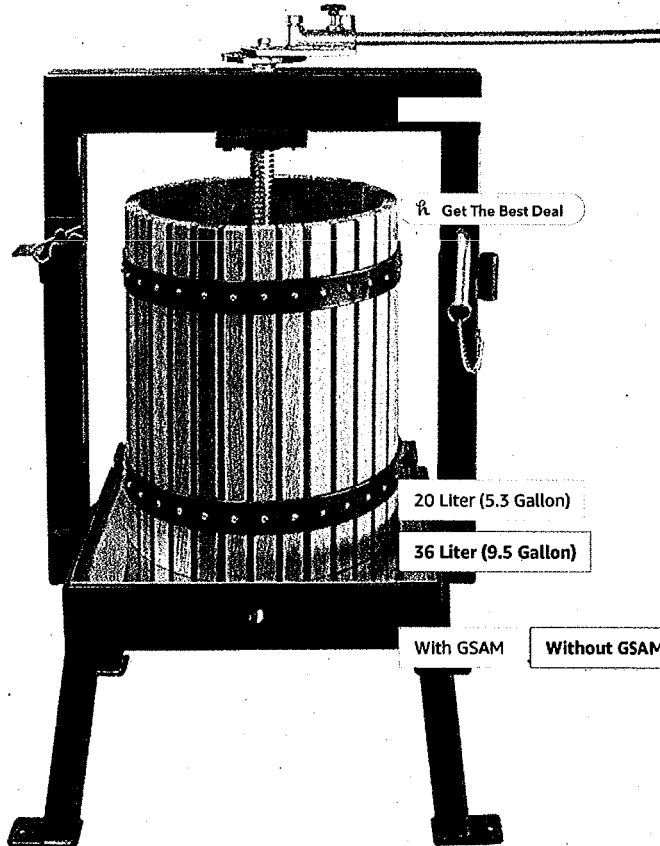
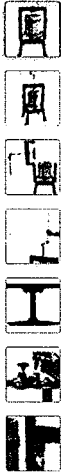

36

ws  
ruit p...

Get The Best Deal

20 Liter (5.3 Gallon)

36 Liter (9.5 Gallon)

With GSAM

Without GSAM

meter  
essure

: easily

Roll over image to zoom in

- Fruit stainless steel juice pan with 1" drain pipe
- Full 1 year warranty

New (1) from \$439.95 & FREE shipping.

Report incorrect product information.

Explore the Home Gift Guide



Instant Pots



Breville Appliances



Keurig Coffee Makers

Pratico Kitchen

Securely Store  
Homemade Brews  
with Airtight Seal

oz Beer Bottles with  
nic Cap for

Ad feedback

Share

\$439.95

& FREE Shipping

FREE Delivery Thursday, Dec. 27 -  
Monday, Dec. 31 Details

Only 11 left in stock -  
order soon.

Ships from and sold by Pleasant  
Hill Grain.

Qty: 1

\$439.95 + Free Shipping

Add to Cart

Buy Now

Turn on 1-Click ordering for this browser

Deliver to kimberly -  
Placerville 95667

Add to List

Add to Wedding Registry

Have one to sell?

Sell on Amazon

Frequently bought together